

OUTSIDE DIMENSIONS

Dimensions in mm

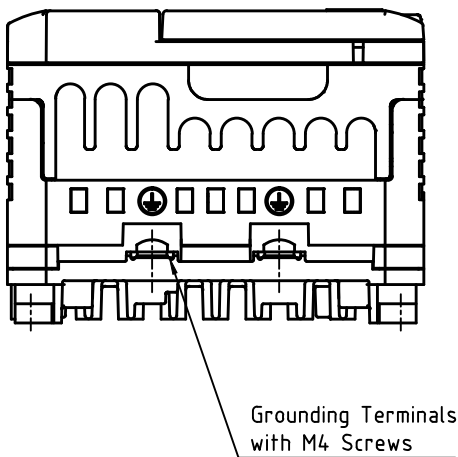

許容スペース Minimum allowable space

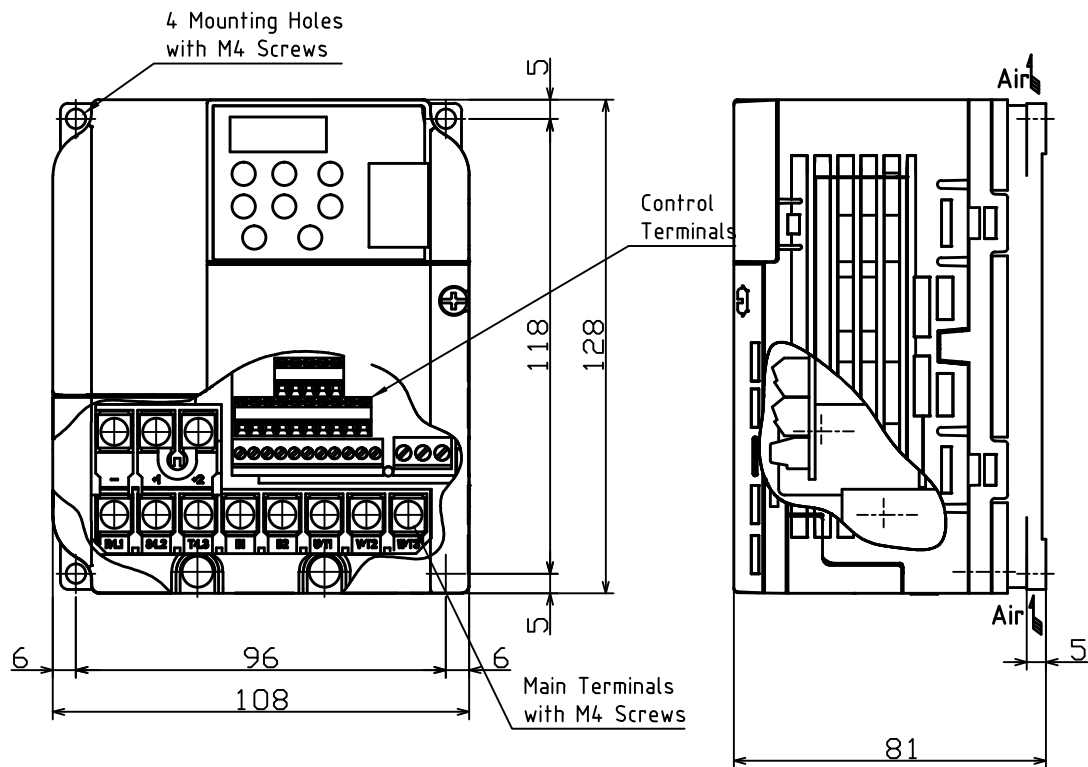
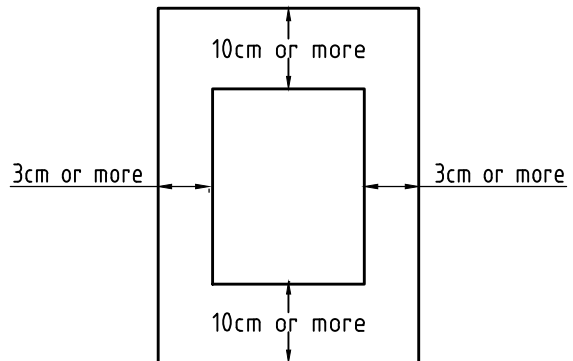

Mass: 1.0kg

HF5204-A20, HFX204-A20

ご注文主: Customer:	△	Inverter HF-520/HF-X20 0.2kW/3φ400V
製番: Manuf. No.:	△	
台数: On Order:	△	

Sumitomo Drive Technologies

Sumitomo Heavy Industries, Ltd.

DWG. No. JT530AW

DATE APR. 23. 2014